





Endo-Model

Rotational and Hinge Knee Prosthesis

CE0482

Explanation of Pictograms			
	Manufacturer		Article number
	Material number		Product meets the applicable requirements, which are regulated in the EU harmonization legislation for the affixing of the CE marking.

Endo-Model

Rotational and Hinge Knee Prosthesis

System Description

- 02 Endo-Model Rotational Knee
- 06 Assembly: Plateau with anti-luxation device
- 08 LINK PorEx Technology (TiNbN = Titanium Niobium Nitride)
- 09 Endo-Model Hinge Knee

10 **Indications / Contraindications**

11 **Literature**

Surgical Technique

Endo-Model Rotational and Hinge Knee with anti-luxation device

- 12 Approach
- 13 Opening
- 15 Femoral Preparation for Endo-Model Rotational and Hinge Knee
- 19 Tibial Preparation for Endo-Model Rotational and Hinge Knee
- Implantation for:
- 21 A. Endo-Model Rotational Knee
- 24 B. Endo-Model Hinge Knee

- 29 **Accessories:** X-ray Templates,
detailed Catalogs

Important Information

Endo-Model Rotational Knee Prosthesis

Building on the excellent results obtained with the St. Georg Hinge Knee Prosthesis, the rotational knee prosthesis was developed in 1979, which allows axial rotation and reduces the forces acting on the prosthesis anchorage.

The intracondylar Endo-Model Rotational Knee Prosthesis is available in two versions (right and left) and four implant sizes:

Material: CoCrMo Alloy, UHMW Polyethylene



Retaining the low friction principle, the physiological movement of the rotational knee prosthesis is optimal because the pivot point is within the physiological area. Flexion and rotation of the rotational knee prosthesis take place in a cross joint.

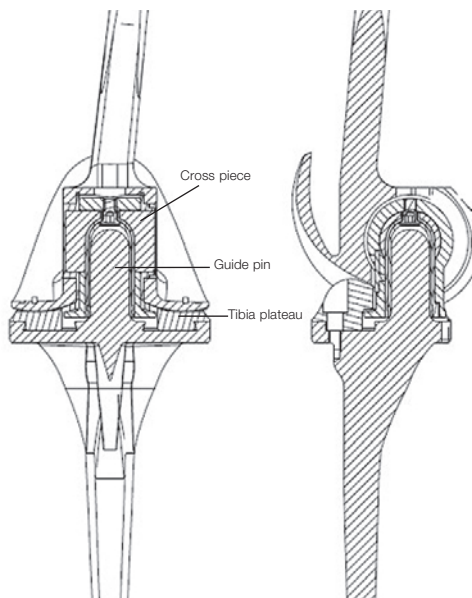

Over-extension amounts to 2°. The Endo-Model Rotational Knee Prosthesis allows flexion of up to 142°. In addition, the kinematics of this design provide physiological rotation, with elastic transmission of forces enabled by the special shape of the tibial running surface.

With every step, and even more in the case of a fall, torsional stresses arise and act on the implant anchorage, with a negative effect on the lifespan of the prosthesis. The elastic transmission of forces by the construction of the prosthesis protects the bone cement/prosthesis and bone cement/bone interfaces, due to load reduction.

Because of the favourable dimensions of the rotational knee prosthesis, the resection required on the tibio femoral joint plane is very small – only 14 mm (1). The size of the intracondylar portion depends on the implant size but is only between 28 and 34 mm (2). This is an important positive point in terms of subsequent revision surgery.

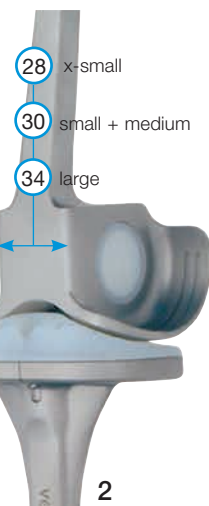
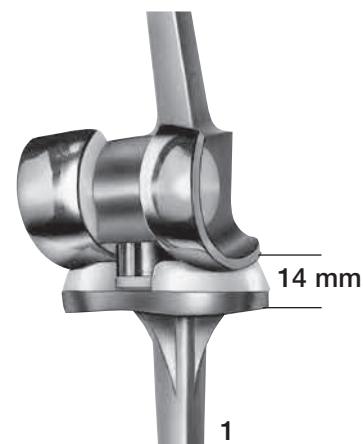

The dimensions and shape of the rotational knee prosthesis allow a good overview of the operative field. The femoral and tibial components are coupled by simply slotting the two parts together (3). The prostheses feature an anti-dislocation device (4). Implantation is made easier by just a few easy-to-use instruments.

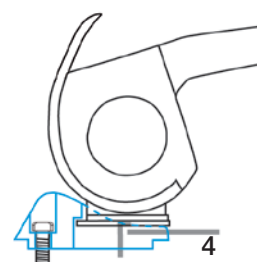

Endo-Model Rotational Knee Prosthesis

In knee replacement, advancement of the patella or of the patella bearing surface is often observed. By moving the femoral component dorsally relative to the tibial axis, physiological movement is achieved in the patello-femoral joint as well. This protects against progression of retropatellar arthrosis.

Rotation of the prosthesis ends in extension by form closure, which ensures a secure standing position. Rotation increases continuously with flexion. This rotation is limited primarily by the capsule-ligament apparatus (5).

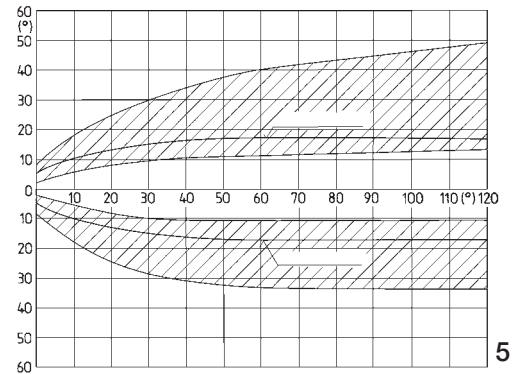

The extent of free rotation is a function of flexion, as is the region of smoothly slowed down rotation (for constructional reasons) (hatched area).

Engelbrecht E.: Die Rotationsendoprothese des Kniegelenks, Springer-Verlag 1984, ISBN: 978-3-642-69819-4 (Print) 978-3-642-69818-7 (Online)

The shape of the running surfaces, which are in contact with each other, means that further rotation is damped elastically by the bodyweight's bearing-down on the joint.

The femoral component of the rotational knee prosthesis features a physiological valgus position of 6° (6).

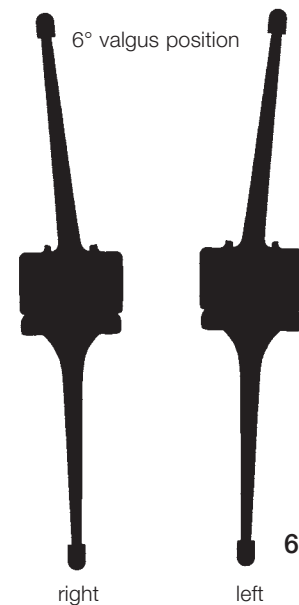

Both prosthesis components are broadly supported on their corresponding joint surfaces, such that the compressive strength of the cancellous bone is not exceeded. The runners of the femoral component are anatomically shaped (7).



The prosthesis stems increase the security of the alignment. The cross-section is rectangular with large transition radii and no sharp edges. Star-shaped polyethylene centralizers at the end of the stems ensure that each stem is centrally positioned in the medullary canal (8), thus avoiding any direct contact between the metal stem and the inner cortex.

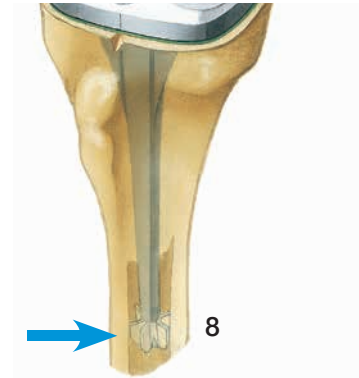

The Endo-Model Rotational Knee Prosthesis offers an optimal implant anchorage. Because the stem has no surface structuring at all, there is nothing to hinder extraction of the prosthesis during a later revision procedure (9).

When the components are being knocked out of the cement bed, the centralizer usually breaks off and can then be drilled out in a second step.

If the cross joint is worn out, e.g. in the case of a malaligned prosthesis, it can be exchanged in a revision operation without the need to remove the femoral or tibial component.



Endo-Model Assembly: Plateau with anti-luxation device



After cementation of tibial and femoral components the UHMWPE plateau is removed from the tibial tray by loosening the trial screw. With the knee in flexion both components are assembled.

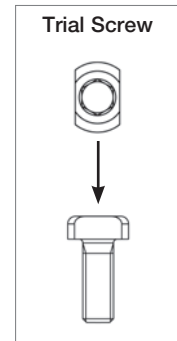

The tibial plateau is attached to the introducer and slid between the femoral and tibial components so that its medial lip grabs over the flange of the femoral bushing. Care must be taken that the dovetailed medial and lateral parts fit into the groove at the posterior rim of the metal tibial tray (fig. B).

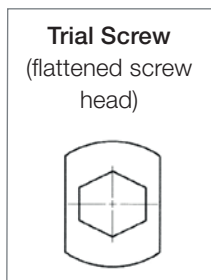
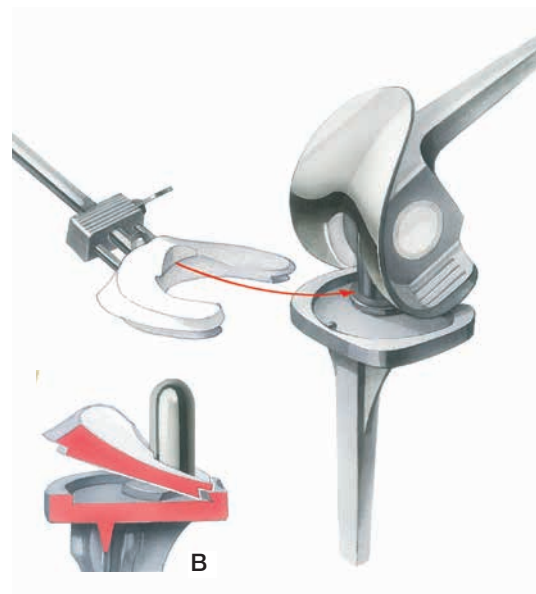

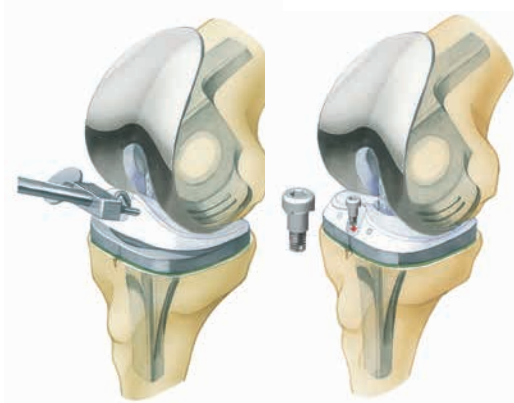

In this position the UHMWPE plateau is pressed down into the metal tray and firmly fixed by the self-locking screw.

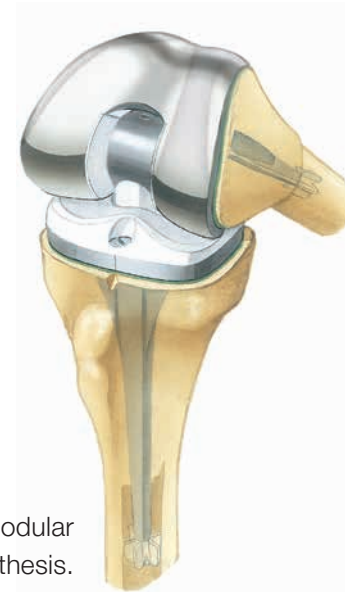

Implanted Endo-Model Modular Knee Prosthesis.

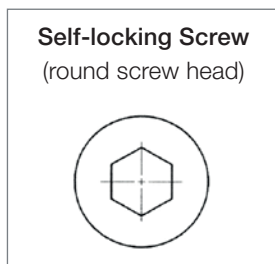
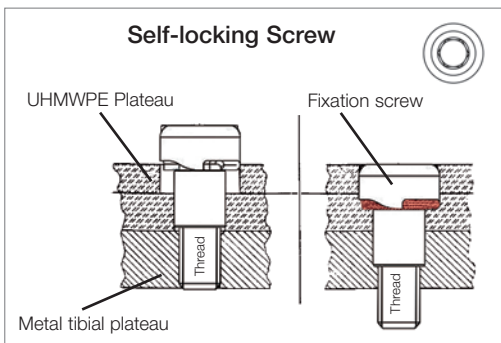

Endo-Model Rotational Knee Joint Prosthesis with LINK PorEx Technology



LINK PorEx Technology

(TiNbN = Titanium Niobium Nitride)

The LINK PorEx surface modification leads to a ceramic-like surface, which significantly reduces the release of ions from the substrate and can improve tolerance in patients who are sensitive to metal.¹

This surface modification is extremely hard and possesses abrasion properties similar to those of ceramics. These qualities and the wetting angle of the surface give it a low friction coefficient when in contact with fluids.

¹ Internal technical report: Study of the influence of TiNbN-coating on the ion release of CrCrMo-alloys in SBF buffer simulator testing

Endo-Model Hinge Knee Joint Prosthesis Endo-Model

The external shape, dimensions and sizes of the **Endo-Model Hinge Knee Prosthesis** correspond to those of the Endo-Model Rotational Knee Prosthesis. As the implant beds required for the hinged and rotational versions are identical, the decision whether to use a rotational or a more stabilizing hinged knee prosthesis can be made intraoperatively.

Connecting piece **A**, which is fixed to the tibial component and links it to the femoral component of the hinge knee prosthesis, features a borehole for the joint axis **B**. The ventral borehole **C** is provided for the set screw **D**, whose tip fits into the borehole **E** on the axis. Once the upper and lower components have been joined, the axis is locked with the headless screw.

From inside the intracondylar box, polyethylene bearings for the prosthesis axis are pushed into the medial and lateral boreholes. The upper and lower prosthesis components are joined by introducing the tibial connecting piece into the intracondylar box of the femoral component, such that the prosthesis axis can be inserted (always from the medial aspect) using the threaded rod. Articulation takes place between the prosthesis axis and the two bearings.

The **Endo-Model Hinge Knee Prosthesis** is delivered readily assembled and in a sterile condition. To disassemble it, turn the set screw **D** anticlockwise. Screw the threaded rod onto the prosthesis axis **B**, which is then pulled out. Push the bearings **F** of the upper prosthesis component into the intracondylar box and remove them. (**Note:** The open bearing must be placed medially when the bearings are reinserted).

The package contains two sterile trial bearings (not autoclavable). These are inserted into the upper prosthesis component during surgery; after the trial run, they are exchanged for the definitive bearings. These, too, can be exchanged if necessary in a second intervention.

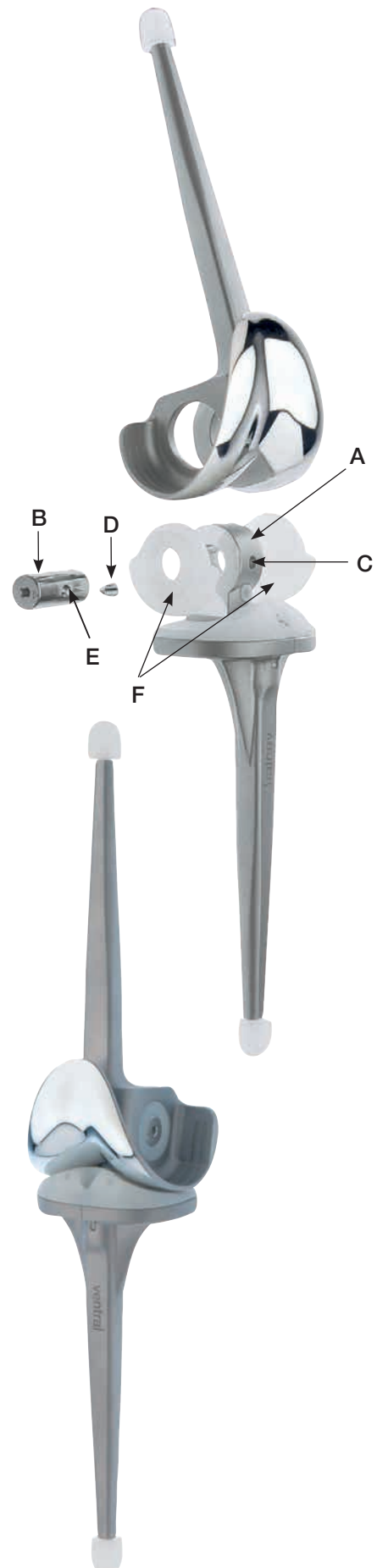

Specified Indications and Contraindications for Endo-Model Rotating and Pure Hinge Knee Prosthesis	Products	Rotating Hinge	Pure Hinge	Components with LINK PorEx (TiNbN) surface modification
General Indications				
<ul style="list-style-type: none"> Mobility limiting diseases, fractures or defects of the knee joint, distal femur or proximal tibia which cannot be treated by conservative or osteosynthetic procedures 		X	X	X
Indications				
<ul style="list-style-type: none"> Primary and secondary osteoarthritis 		X	X	X
<ul style="list-style-type: none"> Rheumatoid arthritis 		X	X	X
<ul style="list-style-type: none"> Revision after primary or revision total knee replacement 		X	X	X
<ul style="list-style-type: none"> Bone necroses which won't compromise the successful implantation of a hinged total knee endoprosthesis 		X	X	X
<ul style="list-style-type: none"> Varus and valgus deformity with contracture or laxity of the medial or lateral stabilizers 		X	X	X
<ul style="list-style-type: none"> Extreme cases of varus/valgus deformities (20-30°), rheumatoid arthritis, muscular deficiency and any kind of genu laxum 		-	X	-
<ul style="list-style-type: none"> Oncological and revision surgery in lower limb (in conjunction with the Endo-Model-W and the Megasytem-C) 		X	X	-
<ul style="list-style-type: none"> Sensitization against one or more components of used CoCrMo implant materials 		-	-	X
Contraindications				
<ul style="list-style-type: none"> Acute or chronic infections, local and systemic insofar as they compromise the successful implantation of a hinged total knee endoprosthesis 		X	X	X
<ul style="list-style-type: none"> Allergies to (implant) materials 		X	X	-
<ul style="list-style-type: none"> Distinctive muscular, nerve, vascular or other diseases which put the affected limb at risk 		X	X	X
<ul style="list-style-type: none"> Insufficient bone integrity which prevents a stable anchorage of the prosthesis 		X	X	X

These indications/contraindications refer to standard cases. The ultimate decision on whether or not an implant is suitable for a patient must be made by the surgeon based on his/her individual analysis and his/her experience.

- E. Engelbrecht, A. Siegel, J. Röttger, and Prof. H. W. Buchholz*
Statistics of Total Knee Replacement: Partial and Total Knee Replacement, Design St. Georg
Journal of Clinical Orthopaedics, 1976, No. 120, pp 54-64 (K3)
- E. Engelbrecht, E. Nieder, E. Strickle, A. Keller
Intrakondyläre Kniegelenkendoprothese mit Rotationsmöglichkeit – ENDO-MODELL®
CHIRURG 52: 368-375 (1981) (K1)
- R. Dederich und L. Wolf
Kniegelenkprothesen-Nachuntersuchungsergebnisse
Unfallheilkunde (1982) 85:359-368 (K2)
- J. Röttger, K. Heinert
Die Knieendoprothesensysteme (Schlitten- und Scharnierprinzip). Beobachtungen und Ergebnisse nach 10 Jahren Erfahrung mit über 3700 Operationen.
Z. Orthop. 122(1984) 818-826 (K17)
- E. Nieder, E. Engelbrecht, A. Keller
Totale intrakondyläre Scharniergelenkendoprothese mit Rotationsmöglichkeit – Endo-Modell®
Sonderdruck aus Heft 5: Orthopädische Praxis, 1987, 23. Jahrgang, Seite 402-412 (K34)
- K. Heinert, E. Engelbrecht
Total Knee Replacement - Experience with a Surface and Total Knee Replacement: Further Development of the Model St. Georg®. 2400 Sledges and Hinges
Proceedings of the International Symposium on Total Knee Replacement, May 19-20, 1987, Nagoya, Japan Springer Verlag.; Berlin Heidelberg, New York Tokyo (1987), pp 257-273 (K53)
- E. Engelbrecht, M.D.
The Tibial Rotating Knee Prosthesis "Endo" Model: Surg. Technique
The Journal of Orthopaedic Surgical Techniques, Volume 3, Number 2, 1987 (K36)
- K. Heinert, E. Engelbrecht
Langzeitvergleich der Knie-Endoprothesensysteme St. Georg® 10-Jahres-Überlebensraten von 2236 Schlitten- und Scharnier-Endoprothesen
Der Chirurg (1988) 59:755-762 (K38)
- F. Madsen, P. Kjarsgaard-Andersen, M. Juhl, O. Sneppen
A Custom-Made Prosthesis for the Treatment of Supracondylar Femoral Fractures after Total Knee Arthroplasty: Report of Four Cases
Journal of Orthopaedic Trauma, Vol. 3, No. 4, pp. 333-337, 1989 (K42)
- E. Nieder
Schlittenprothese, Rotationsknie und Scharnierprothese Modell St. Georg® und Endo-Modell®. Differentialtherapie in der primären Kniegelenkalloarthroplastik
Orthopäde (1991) 20:170-180 (K45)
- G. von Förster, D. Klüber und U. Käbler
Mittel- bis langfristige Ergebnisse nach Behandlung von 118 periprothetischen Infektionen nach Kniegelenkersatz durch einzeitige Austauschoperationen
Orthopäde(1991) 20: 244-252 (K46)
- Adolph V. Lombardi, Jr, Thomas H. Mallory, Robert W. Eberle, and Joanne B. Adams
Results of Revision Total Knee Arthroplasty Using Constrained Prostheses
Seminars in Arthroplasty, Vol 7, No. 4 (October), 1996: pp 349-355
- E. Engelbrecht, E. Nieder, D. Klüber
Reconstruction of the Knee - Ten to Twenty Years of Knee Arthroplasty at the Endo-Klinik: A Report on the Long-term Follow-up of the St. Georg® Hinge and the Medium-term Follow-up of the Rotating Knee Endo-Modell®
Springer Verlag: Tokyo, Berlin, Heidelberg, New York (1997) (K57)
- E. Nieder
Revisionsalloarthroplastik des Kniegelenks
*Sonderausgabe aus: Orthopädische Operationslehre, Band II/1: Becken und untere Extremität
Herausgegeben von R. Bauer, F. Kerschbaumer und S. Poisel*
- F. Alt, U. Sonnekalb, N. Walker
Unikondyläre Schlittenprothese versus scharniergeführte Totalendoprothesen des Kniegelenkes
Orthopädische Praxis 1/98, 34. Jahrgang, Seite 20-24, 1998 (K61)
- A. V. Lombardi, T. H. Mallory, R. E. Eberle, J. B. Adams
Rotating Hinge Prosthesis in Revision Total Knee Arthroplasty: Indications and Results
A Reprint from Surgical Technology International VI, 1998 (K55)
- E. Nieder, G.W. Baars, A. Keller
Totaler Tibia-Ersatz Endo-Modell®
Orthopädie Aktuell: Nr. 5/1998, LINK News (K60)
- S. Schill, H. Thabe
Die periprothetische Knieinfektion – Therapiekonzept, Wertigkeit und mittelfristige Ergebnisse
Aktuelle Rheumatologie, Heft 5, 24. Jahrgang, 1999, pp 153-160 (K70)
- G.W. Baars
Knieendoprothetik: Das optimale Implantat für jeweilige Indikation finden
Orthopäde 2000 (Suppl1) 29: S1-2
- M. Zinck, R. Sellkau
Rotationsknieprothese Endo-Modell®- Geführter Oberflächenersatz mit Sti(e)
Orthopäde 2000 (Suppl1) 29: S 38-42
- M. Crowa, E. Cenna, C. Olivero
Rotating knee prosthesis – Surface or hinge replacement?
Orthopäde 2000 (Suppl1) 29: S 43-44
- J-N. Argenson, J M. Aubaniac
Total Knee arthroplasty in femorotibial instability
Orthopäde 2000.29:S 45-47, Springer Verlag 2000 (K72)
- M. von Knoch, R. Brocks, C. Siegmüller, G. Ribaric, L. Leupolt, G. von Förster
Knieflexion nach Rotationsknieendoprothese
Z. Orthop 2000; 138: 66-68 (K71)
- R.E. Windsor, K. Steinbrink
Controversies in Total Knee Replacement Two-stage exchange is the optimal treatment for an infected total knee replacement
Oxford University Press 2001 (K78)
- Thomas Nau, MD, E. Pfelegerl, MD, J. Erhart, MD, and V. Vecsei, MD
Primary Total Knee Arthroplasty for Periarticular Fractures
The Journal of Arthroplasty, Vol 18, No 8, 2003 (K82)
- G. Petrou, H. Petrou, C. Tilkeridis, T. Stavrakis, T. Kapetsis, N. Kremmidas, M. Gavras
Medium-term results with a primary cemented rotating-hinge total knee replacement
A 7-TO 15-YEAR FOLLOW-UP
J Bone Joint Surg (Br), 2004; 86-B :813-17 (K84)
- M.R. Utting, J.H. Newman
Customised hinged knee replacement as a salvage procedure for failed total knee arthroplasty
The Knee 11 (2004) 475-479 (K86)
- Nayana Joshi, Antonio Navarro-Quilis
Is There a Place for Rotating-Hinge Arthroplasty in Knee Revision Surgery for Aseptic Loosening?
The Journal of Arthroplasty 2008; 23(8):1204-1210 (K94)
- M. Napp, M. Frank, M. Witt
Pathologische Fraktur des distalen Femurs bei Knie-TEP
Der Orthopäde, Band 38, Heft 10, Oktober 2009 (K96)
- Dae Kyung Bae, Sang Jun Song, Kyoung Ho Yoon, Jung Ho Noh
Long-Term Outcome of Total Knee Arthroplasty in Charcot Joint: A 10- to 22- Year Follow-Up
The Journal of Arthroplasty 2009; 24(8):1152-1156 (K98)

Endo-Model Rotational and Hinge Knee Prosthesis
with patella flange and anti-luxation device

Approach

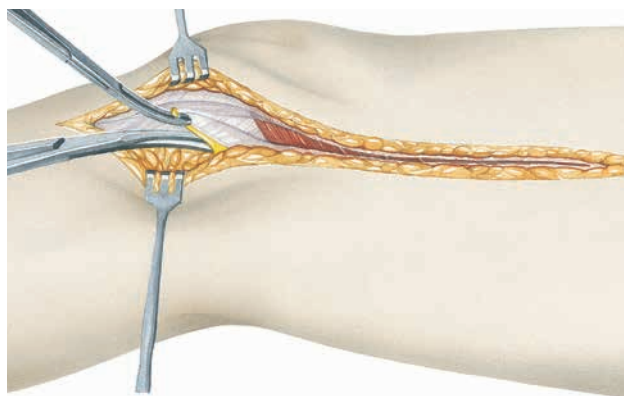

Z1

Modified Payr medial approach.

The skin and fascia are incised with the knee slightly flexed. The infrapatellar branch of the saphenous nerve is resected to allow exposure of the saphenous nerve within the plane of the incision. The distal portion of the vastus medialis is mobilized. The medial patellar retinaculum is divided, and the capsule and synovial membrane are then divided in the plane of the incision. The suprapatellar pouch is opened with a crescentic incision coursing superiorly and medially. Knee flexion is increased and the patella is shifted laterally to open the anterior knee.

The femoral condyles are mobilized by dissecting the following structures in this order:

1. Medial collateral ligament
2. Cruciate ligaments
3. Lateral collateral ligament

The posterior capsular ligaments are carefully mobilized.

Endo-Model Prostheses Design:

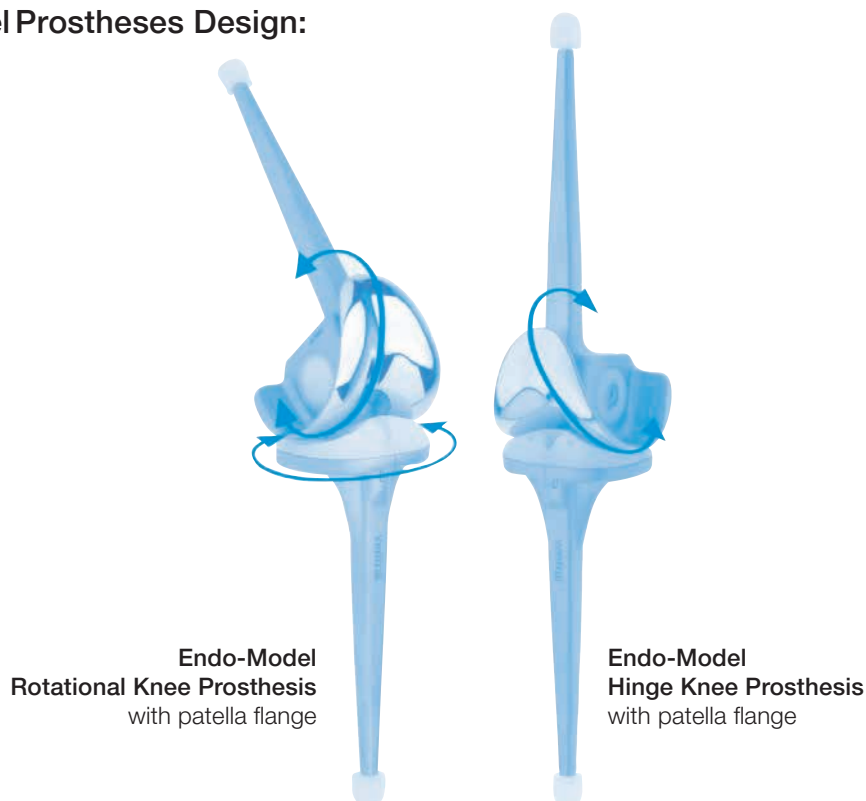

Opening

For Endo-Model Rotational Knee and Hinge Knee Prostheses



Z2

A rein placed posteriorly around the condyles helps to stabilize the femur when the knee is flexed.

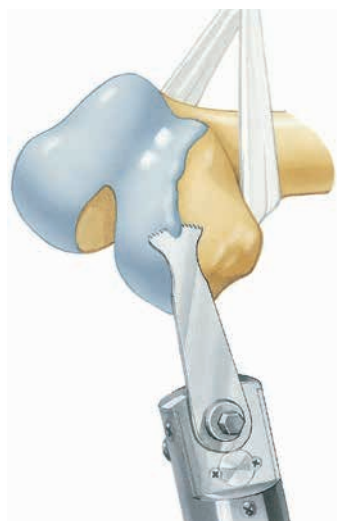

Z3

Osteophytes are removed to restore the physiologic contour of the condyles.

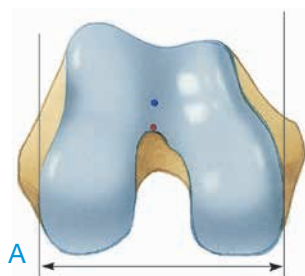

Z4

The width of the condyles determines which size of knee prosthesis to select (A).

The red line indicates the axis resulting from the initial opening of the femoral canal. The blue line indicates the axis of the femur and the final position of the stem of the femoral component (B).

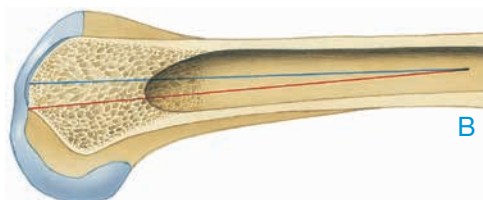

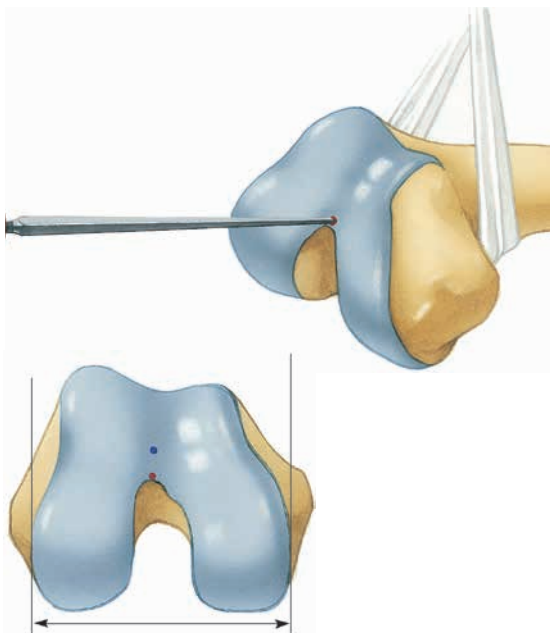

Z5

To initially open the femoral canal, the bone awl is placed at the lowest point (red) of the trochlear groove in the patellofemoral joint. The point lies at the tip of the intercondylar fossa.

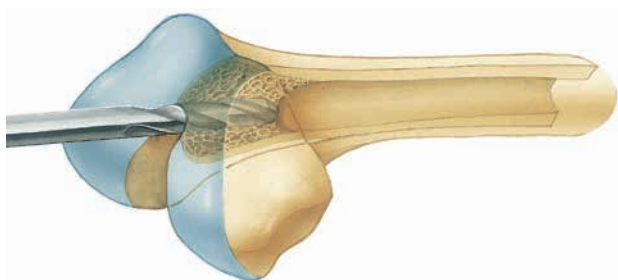

Z6

The femoral canal is opened with an 8 mm twist drill at the point previously marked.

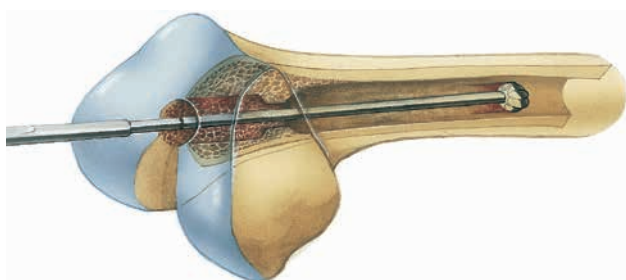

Z7

The femoral canal is carefully widened with a ball reamer.

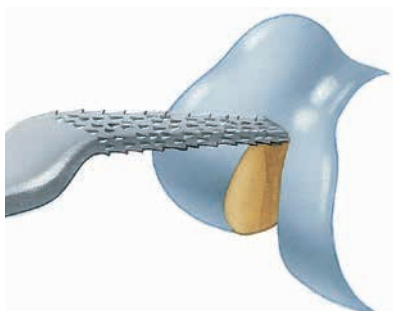

Z8

The femur rasp is used to adjust the opening, made with the twist drill and ball reamer, to fit the shape of the femoral stem.

Femur Preparation

For Rotational Knee and Hinge Knee Prostheses

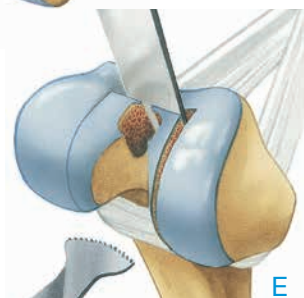
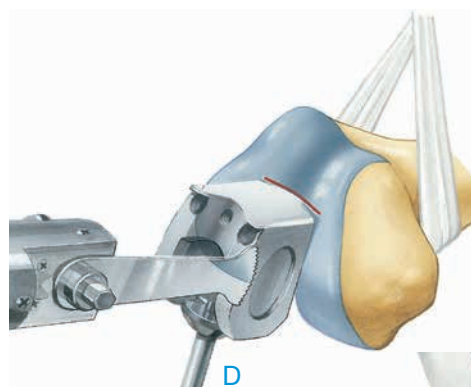
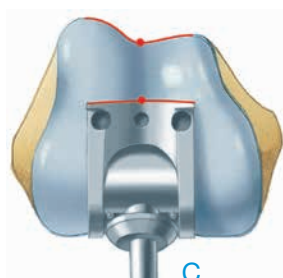
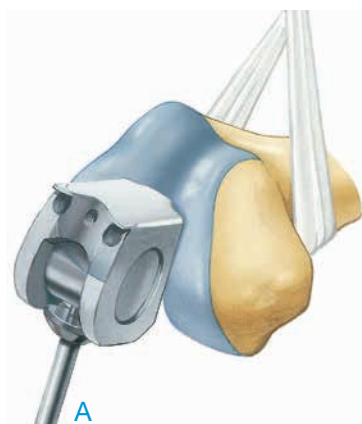

F1

The femoral saw guide corresponds in shape to the portion of the femoral component that will lie within the bone (A).

To keep it centered within the canal, the tip of the stem of the femoral saw guide is equipped with a metal centralizer available in different sizes corresponding to the diameter of the femoral canal. **The centralizer serves as a placeholder, simulating the polyethylene centralizer on the implant (B).**

The femoral saw guide is advanced until its box is in contact with the condyles. The rotational adjustment is correct when the anterior groove of the resection box matches the trochlear groove when viewed from above (C).

F2

Anterior and bilateral femoral osteotomies are performed with the oscillating saw along the surface of the box (D).

The resected bone at the junction of the condyles and the femoral diaphysis should be carefully osteotomized step by step. This should allow the box of the femoral saw guide to be inserted up to the level of the condyles after the resected bone has been removed with a lambotte osteotome (E).

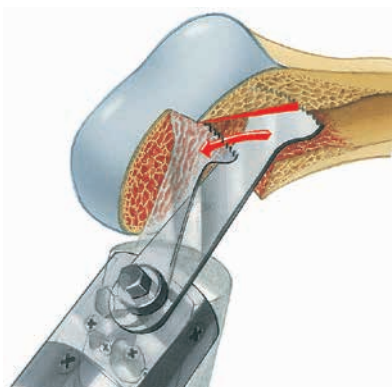

F3

The anterior femoral canal must be adapted to accommodate the slight angle between the anterior surface of the intracondylar box and the stem of the femoral saw guide, and the corresponding angle in the prosthesis. To do this, the cancellous bone posterior to the patellofemoral joint is hollowed out in retrograde fashion with the oscillating saw.

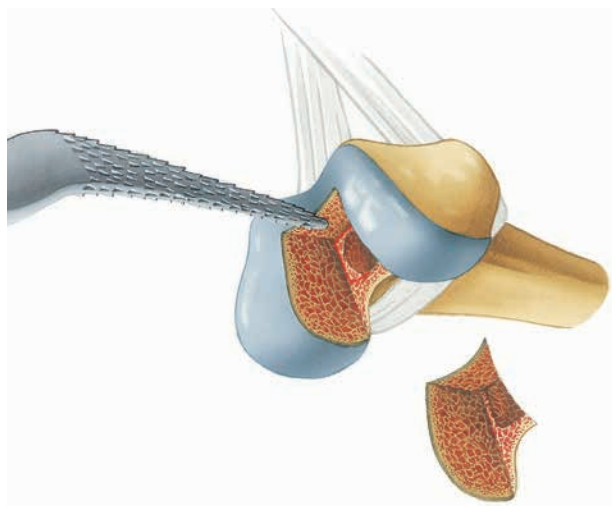

F4

Hollowing out the bone as described creates a step-off in the cancellous bone proximal to the articular surface. This step-off must be removed with the reamer or rasp. If the step-off is not removed, the anterior surface of the box of the femoral saw guide will not fit tightly against the anterior bone. This will create a gap anteriorly between the physiologic trochlear groove and its prosthetic continuation.

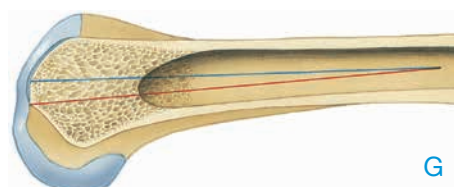
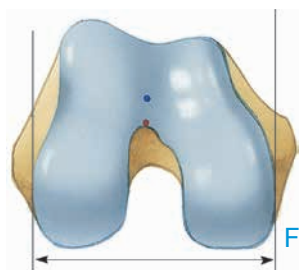

F5

The femoral canal is intentionally opened far posteriorly first (Fig. F, red point). The inserted femoral guide must then be shifted anteriorly (Fig. F, blue point) until the stem of the femoral saw guide (locked in extension) is aligned with the distal femur (Fig. G, blue position of femoral saw guide), so as to prevent hyperextension.

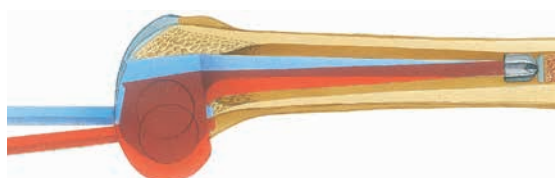

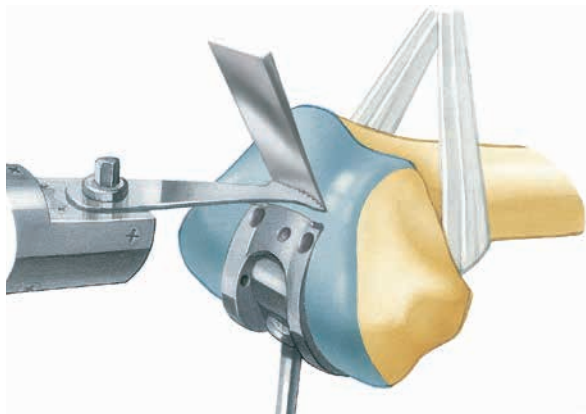

F6

If proper axial alignment of the femoral saw guide cannot be achieved after steps F3 to F4 have been performed, the femoral saw guide will have to be shifted further anteriorly. This requires resection of more bone from the intracondylar portion of the trochlear groove. A lambotte osteotome impacted into the bone can be used to define the extent of the osteotomy. The impacted osteotome also guides the saw blade until the saw has cut a groove in the bone. It is important to perform the resection gradually, verifying proper alignment of the axis of the femoral saw guide with the axis of the femur.

After this additional resection, the steps of hollowing out the cancellous bone proximal to the trochlear groove and removing cancellous bone from the anterior portion of the femoral canal proximal to the joint must be repeated.

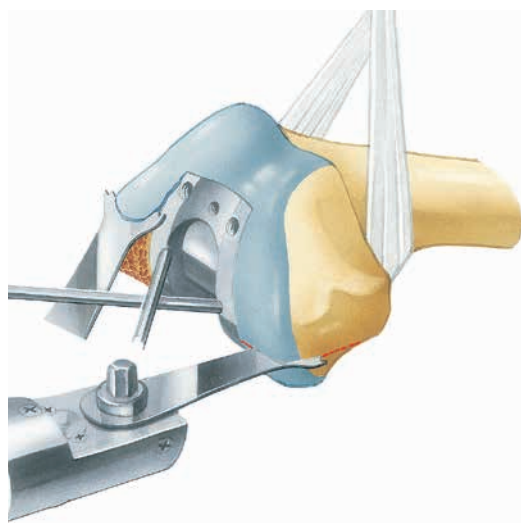

F7-a

The box of the femoral saw guide is advanced into the bone until the contour of the anterior groove of the saw guide is congruent with the trochlear groove in the patellofemoral joint. The femoral saw guide is fixed with two fixation pins. The condyles are then adapted to match the curved surface of the resection box.

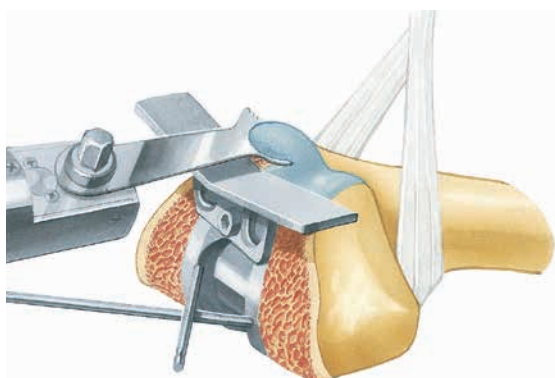

F8-a

The patella glide resection guide is attached to the saw guide and the anterior surface of the distal femur is resected to fit the shape of the implant.

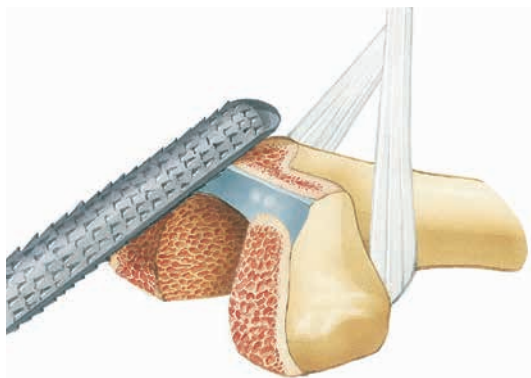

F9-a

The remaining anterior edge is rounded off with a rasp. Residual cartilage should be removed.



F10-a

In sclerotic bone, it is a good idea to achieve a slight curvature of the inner edges of the condyles to match the interior contour of the implant between box and flanges. Soft cancellous bone will conform to the interior contour of the flanges; sclerotic bone must be shaped to fit. Where the medial femoral condyle is sclerotic, cement retention holes are drilled to improve implant fixation.

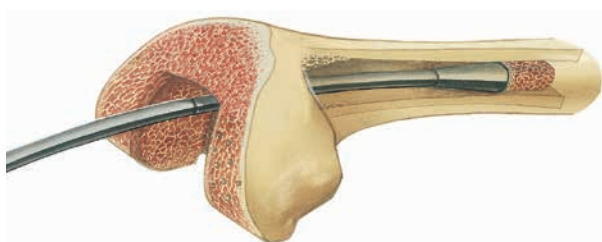

F11-a

A cylindrical bone plug is inserted into the proximal femur to seal the femoral canal. The bone plug is advanced to a depth corresponding to the length of the stem of the femoral component. This bone plug helps to achieve hemostasis in the proximal medullary canal. It seals the canal when the cement is later injected during implantation of the femoral component.

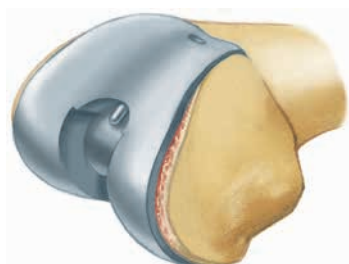

F12-a

The trial prosthesis is inserted into the femoral canal to check the resection. Once the femoral preparation is complete, the femoral component can already be cemented in at this stage. This avoids accidental fracture of the femoral condyles during the operation.

Tibia Preparation

For Endo-Model Rotational Knee and Hinge Knee Prostheses

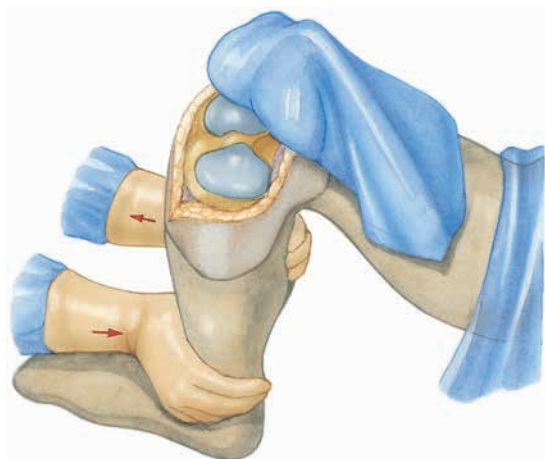

T1

Next, the tibia is exposed. The hand on the opposite side to the approach is placed in the popliteal fossa with the thumb abducted, while the other hand grasps the ankle anteriorly. Applying traction and shear force with the hands with slight external rotation exposes the proximal tibia.

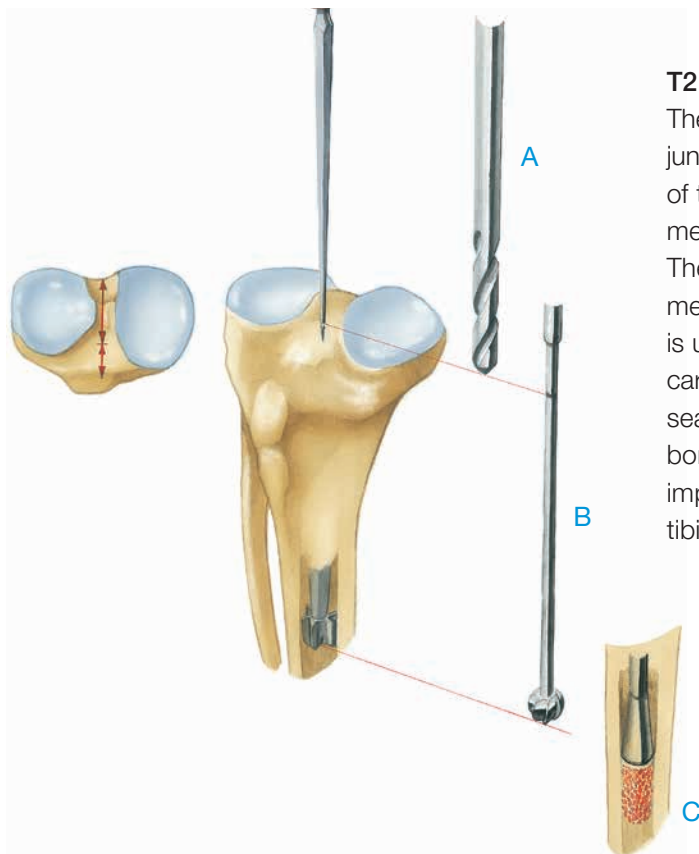

T2

The tibial canal is marked with a broach at the junction between the anterior and middle thirds of the sagittal diameter of the tibial surface, immediately anterior to the intercondylar eminence. The point described lies above the center of the medullary canal of the tibia. An 8 mm-twist-drill (A) is used to open the tibial canal. The tibial canal is then carefully enlarged distally with a ball reamer (B). To seal off the distal tibial canal, autologous cancellous bone is pressed deep into the tibial canal with an impactor, down to a point inferior to the tip of the tibial component stem (C).

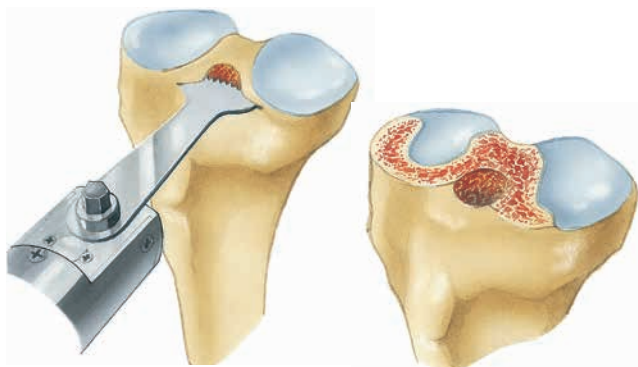

T3

The intercondylar eminence is removed down to the level of the intact tibial plateau to create a reference plane for measuring the bone to be resected.

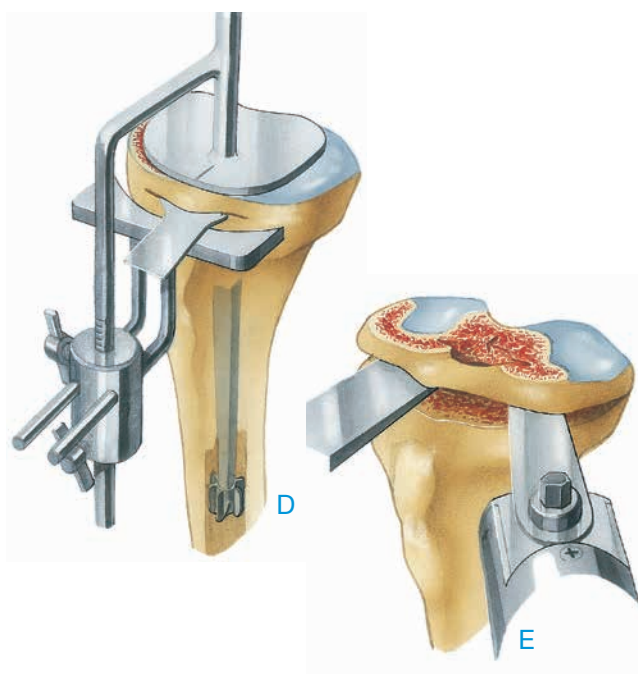

T4

The tibial saw guide is inserted into the tibial canal, and aligned with the axis of the tibia in the median lateral plane and coronal plane. The height of the tibial saw guide is adjusted such that 10 mm can be resected. This resection level corresponds to the thickness of the thinnest portion of the implant's polyethylene plateau (D).

To achieve a correct cutting geometry, sawblades with a thickness of 1.24 mm or 1.27 mm must be used!

After the tibial saw guide is removed, the osteotomy is deepened. The resected bone is mobilized and sharply dissected off the posterior capsule with an osteotome (E).

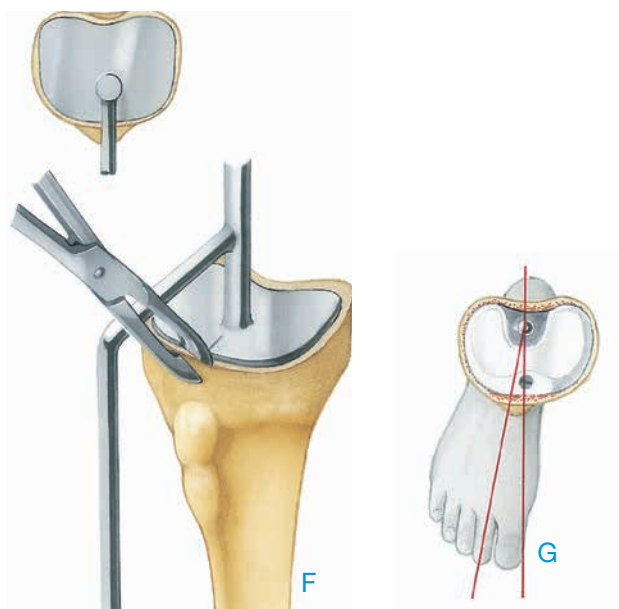

T5

The alignment guide is removed from the saw guide to determine rotational alignment.

The mark on the metal plateau of the tibial saw guide and the horizontal part of its anterior alignment rod will indicate an area between the middle of the tibial tuberosity and its medial margin (F). The second digital ray of the foot should exhibit external rotation between 0° and 10° (G).

The rotational alignment of the tibial component corresponding to the mark on the metal plateau is best marked on the anterior cortex of the proximal tibia by a small notch made with a narrow bone rongeur (F).

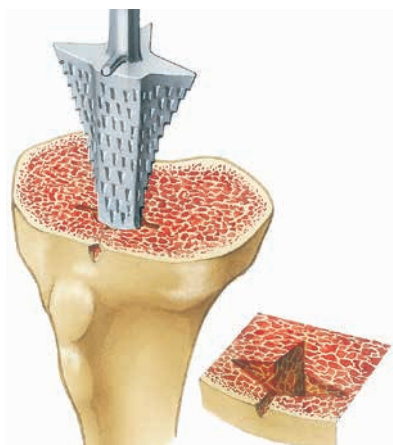

T6

The tibial broach, which is shaped like the tibial stem of the implant, is used to shape the tibial canal. The anterior pin on the rasp is aligned with the notch made in the proximal tibia. The tibia reamer is successively driven in and withdrawn until it can be inserted down to the level of the resection plane.

Implantation

For Endo-Model Rotational Knee Prosthesis (**Fig. I1-a to I9-a**)



I1-a

Optionally, trial femoral and tibial prostheses can be inserted and coupled for trial reduction.

Defecits in flexion and extension gap are balanced by using femoral segments or proximal tibial spacers.

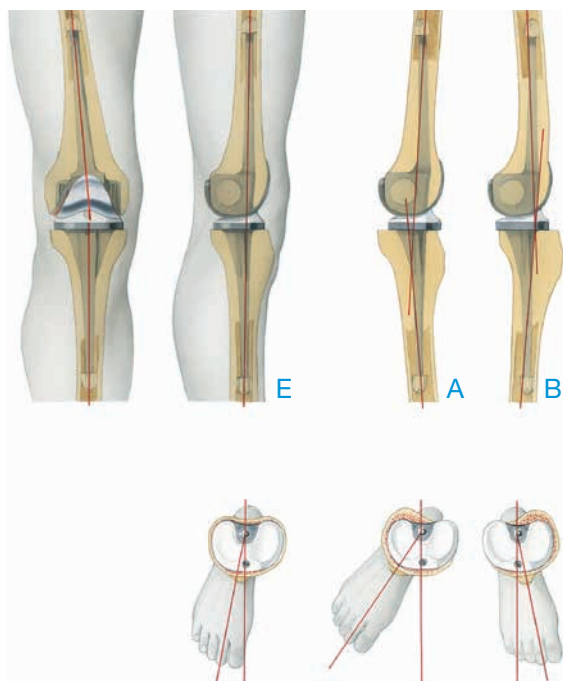

I2-a

It is now important to verify correct sagittal and rotational alignment of the implant before cementing the implant components in place:

- A hyperextension**
- B impaired extension**
- C external hyperrotation**
- D internal hyperrotation**

must be corrected.

Figures E and F show correct axial alignment of the seated implant.

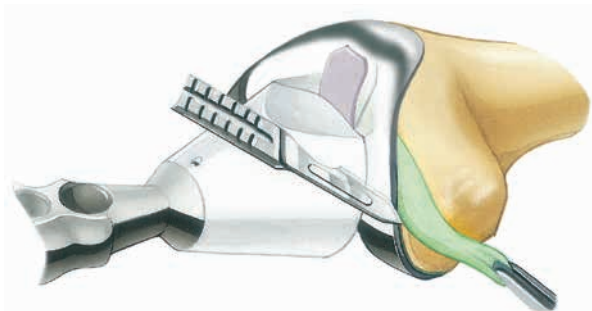

I3-a

Once it has been verified that the implant is correctly positioned, the centralizer is mounted and the components are individually cemented in place. It is recommended that the femoral component normally be implanted with 80 g of bone cement. Excess cement at the sides is removed.

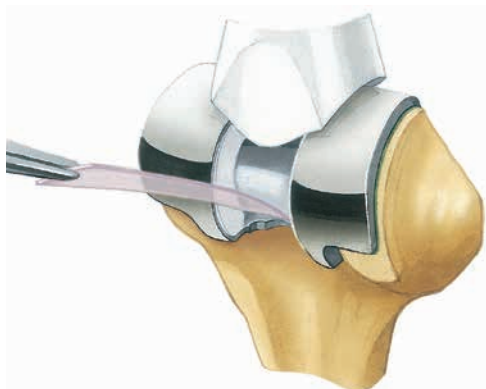

I4-a

The plastic strip that protects the joint mechanism from the entry of cement is removed. The strip should be pulled posteriorly.

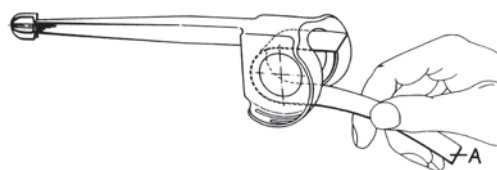

I5-a

Before the tibial component – with the mounted centralizer – is cemented with at least 40 g of bone cement, the tibial canal is sealed with a bone plug. Note the marked rotational position when aligning the implant.

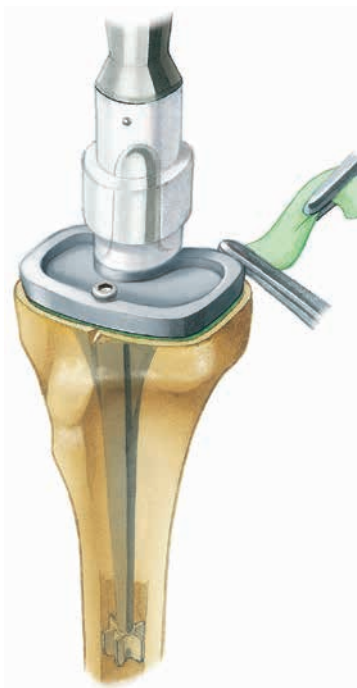

Caution:

The tibial component may only be cemented without the polyethylene plateau removed where the trial screw has been inserted to a maximum depth.

To remove the polyethylene plateau, the trial screw is removed and the plateau taken off of the metal tibial tray using the tibial plateau introducer. Subsequently, the trial screw is reintroduced until it stops in the metal plateau. **This is necessary to prevent cement from entering the threaded hole in the metal plateau.**

Excess cement is removed.

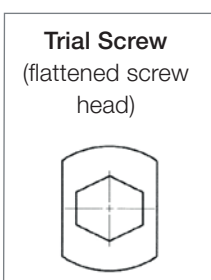

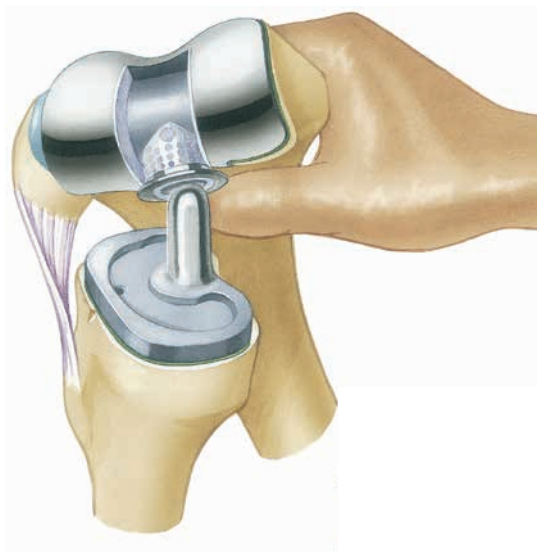

I6-a

Before the cemented components are fitted together, the polyethylene plateau still has to be removed from the tibial metal tray. With the knee flexed, the femoral component is inserted onto the pin of the tibial component.

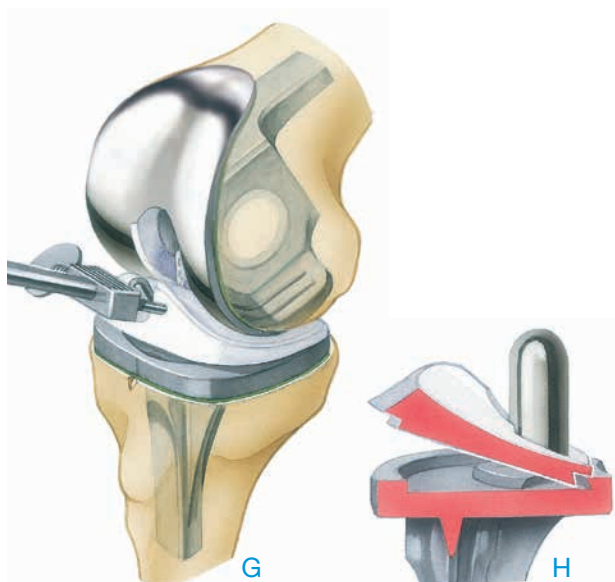

I7-a

To insert the polyethylene tibial plateau, the femoral component is lifted slightly. The tibial plateau is then inserted from an interior direction between the proximal and distal component of the prosthesis (G).

Care should be taken to ensure that the chamber of the plastic plateau merges with the flange of the femoral component, and that the dovetail recess on the underside of the plastic plateau snaps into the marginal groove on the metal tibial tray (H).



Self-locking Screw
(round screw head)

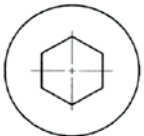

I8-a

The polyethylene plateau is secured in place on the metal tibial tray with the self-locking fixation screw.

Caution:

The self-locking fixation screw must only be used during the final assembly of the plateau. Loosening the fixation screw destroys the screw retention system in the polyethylene plateau, and a new plateau must then be inserted.

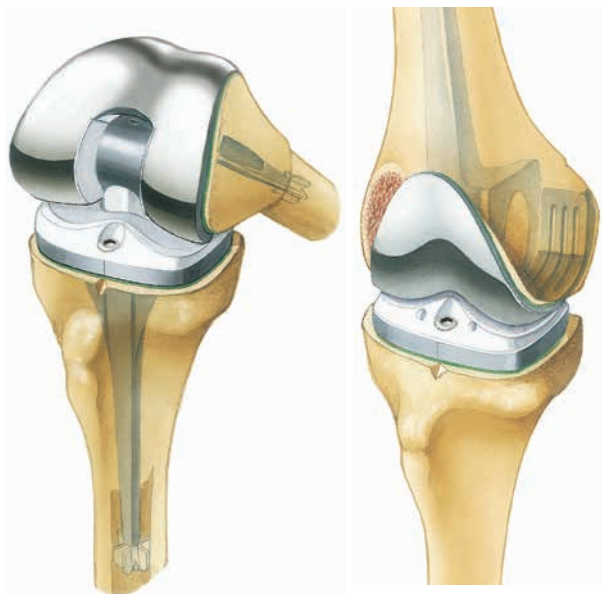

I9-a

The implanted Endo-Model Rotational Knee Prosthesis should allow up to 90° of flexion, depending on the soft tissue structures. In extension, a resilient extension impairment of approximately 5° is optimal. This ex-tension impairment helps to ensure secure contact between the two prosthesis components.

Implantation

For Endo-Model Hinge Knee Prosthesis (Fig. I1-b to I12-b)

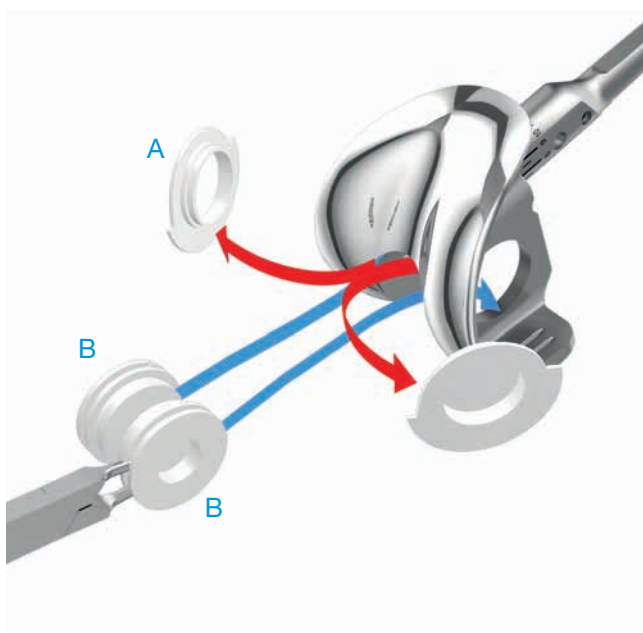

I1-b

After the femur has been prepared to receive the femoral component, the polyethylene bearings (A) are removed from the box of the femoral component and replaced with trial bearings (B). This takes place with special applying forceps (C).

Later, the trial bearings are replaced with the final bearings.



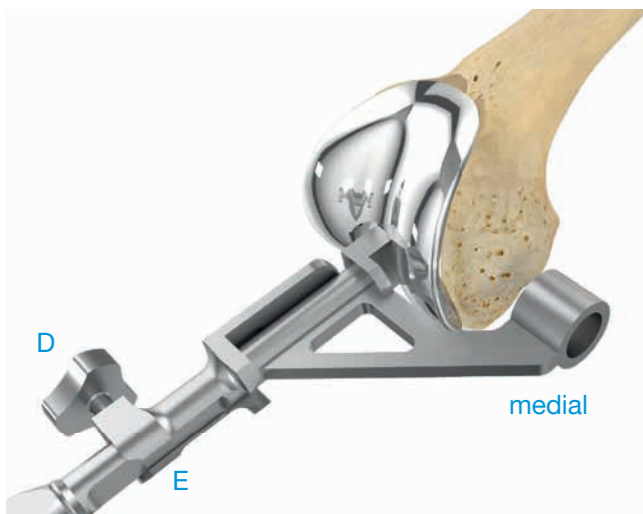

I2-b

The introducer (D) is inserted into the femoral component. The drill guide must lie medially.

The cylindrical portion of the shank of the introducer, opposite the drill guide, is first inserted into the medial bearing. Once the moveable spacer on the shaft of the instrument has been inserted into the intracondylar opening, the introducer is locked in the box of the femoral component by tightening the knurled-head screw (E).

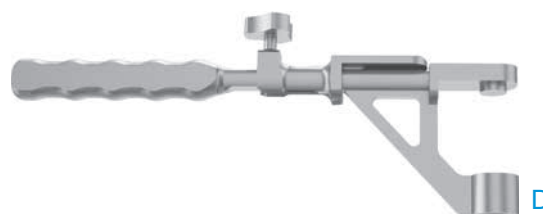

I3-b

A cylinder of bone is placed as a cement restrictor to seal the end of the femoral canal, and the femoral component – including the mounted centralizer – is implanted with at least 80 g of bone cement. Excess bone cement is removed.



I4-b

After the bone cement has hardened, a cylinder of bone is harvested from the medial condyle with the trephine and removed from the reamer for use later on in the procedure.



15-b

The tibial trial component is advanced into the prepared tibial canal with the inserter.

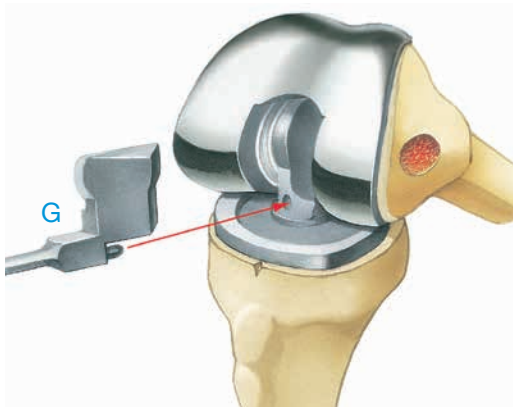

16-b

The femoral and tibial components are connected. The pin (F) on the coupling of the tibial trials is introduced into the lateral trial bearing and locked with the coupling jig (G).

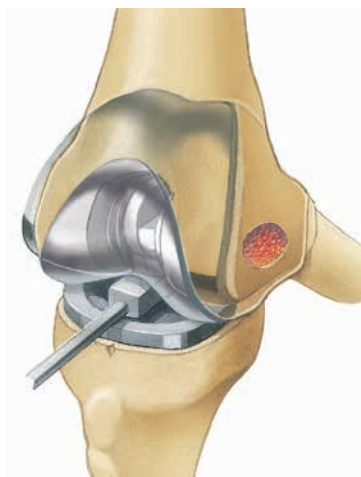
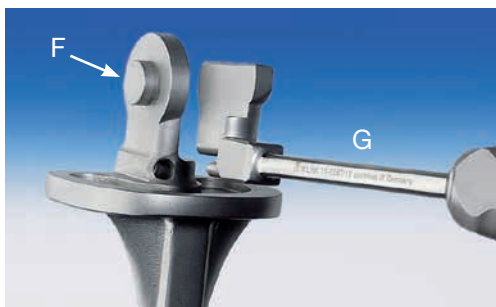

17-b

Correct seating of the prosthesis components with respect to axial alignment, rotation, and sufficient extension and flexion should be verified. In certain cases, additional tibial resection may be required or a spacer should be used.

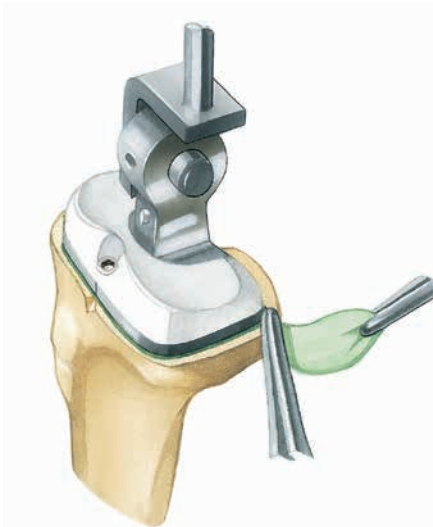

I8-b

The tibial component including the mounted centralizer is implanted with at least 40 g of bone cement. Correct rotation is maintained with the inserter (**H**) while distal pressure is applied to the implant. Excess bone cement is removed.

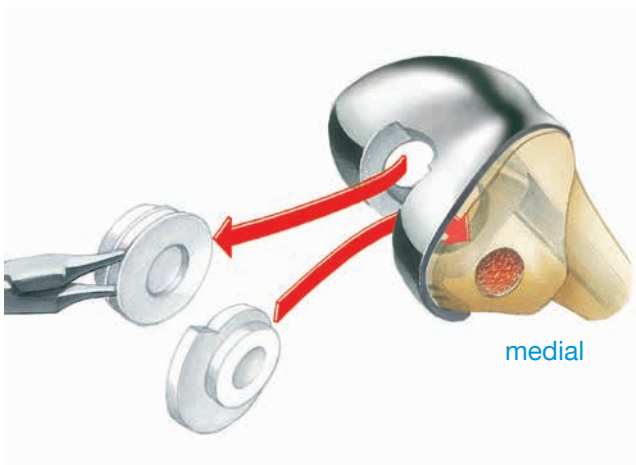

I9-b

Finally, the trial bearings are replaced by the final bearings with the applying forceps (**I**).

Caution:

The open bearing must be placed medially, as the prosthesis axle is introduced medially.



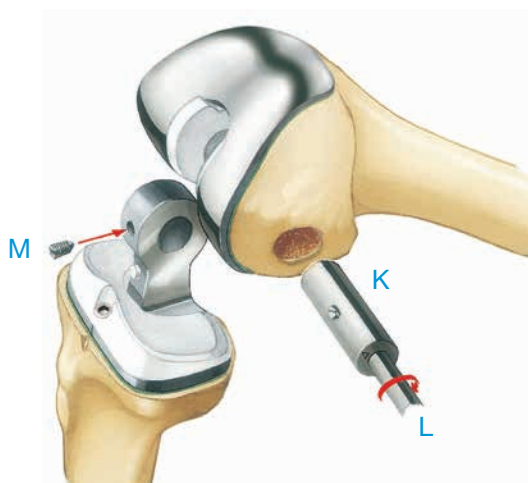

I10-b

The tibial component is fitted into the femoral component and brought into the correct position using the trial axle (J). A test run is performed.

Both prosthesis components are then locked by the final prosthesis axle (K) attached to the threaded rod (L). A set screw (M) tightened firmly into the threaded hole in the axle secures the position of the axle.



I11-b

To prevent the screw from loosening, the end of the threaded hole above the set screw is sealed with a bit of bone cement. The cylinder of bone that was removed with the trephine is reinserted into the medial femoral condyle.

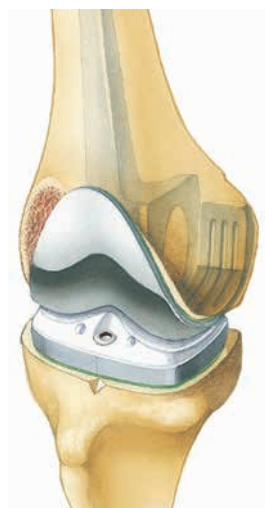

I12-b

Finally implanted: the Endo-Model Hinge Knee Prosthesis.

15-2599/01

X-ray Template for Endo-Model Total Knee Prosthesis (rotational and hinged version)

110% actual size,
1 set of: x-small, small, medium, large

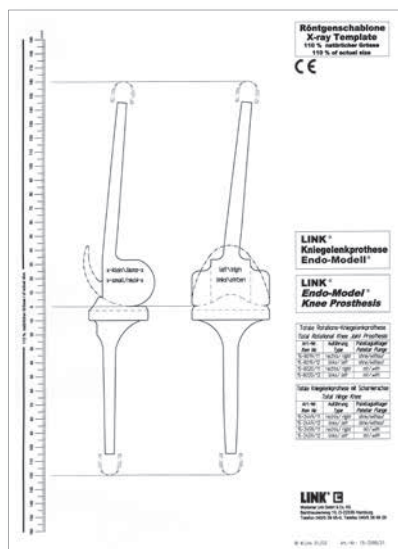

Further Information about:

Endo-Model Rotational and Hinge Knee Prosthesis
Implants & Instruments



Endo-Model Rotational and Hinge Knee Prosthesis
Literature Research

LINK PorEx Technology
(TiNbN = Titanium Niobium Nitride)
for metal sensitive patients
Materials & Surface Modification



For more information please register for our LINK Media Library (link-ortho.com)

Please note the following regarding the use of our implants:

1. Choosing the right implant is very important.

The size and shape of the human bone determines the size and shape of the implant and also limits the load capacity. Implants are not designed to withstand unlimited physical stress. Demands should not exceed normal functional loads.

2. Correct handling of the implant is very important.

Under no circumstances should the shape of a finished implant be altered, as this shortens its life span. Our implants must not be combined with implants from other manufacturers. The instruments indicated in the Surgical Technique must be used to ensure safe implantation of the components.

3. Implants must not be reused.

Implants are supplied sterile and are intended for single use only. Used implants must not be used again.

4. After-treatment is also very important.

The patient must be informed of the limitations of the implant. The load capacity of an implant cannot compare with that of healthy bone!

5. Unless otherwise indicated, implants are supplied in sterile packaging.

Note the following conditions for storage of packaged implants:

- Avoid extreme or sudden changes in temperature.
- Sterile implants in their original, intact protective packaging may be stored in permanent buildings up until the "Use by" date indicated on the packaging.
- They must not be exposed to frost, dampness or direct sunlight, or mechanical damage.
- Implants may be stored in their original packaging for up to 5 years after the date of manufacture. The "Use by" date is indicated on the product label.
- Do not use an implant if the packaging is damaged.

6. Traceability is important.

Please use the documentation stickers provided to ensure traceability.

7. Further information on the material composition is available on request from the manufacturer.

Follow the instructions for use!

Waldemar Link GmbH & Co. KG, Hamburg

All content in this catalog, including text, pictures and data, is protected by law. Every instance of use, whether in part or in whole and which is not permitted by law, is subject to our prior consent. In particular, this applies to the reproduction, editing, translation, publishing, saving, processing, or passing on of content stored in databases or other electronic media and systems, in any manner or form. The information in the catalogs is solely intended to describe the products and does not constitute a guarantee.

The Surgical Technique described has been written to the best of our knowledge and belief, but it does not relieve the surgeon of his/her responsibility to duly consider the particularities of each individual case.

Products shown in this document may not be available in your country. The product availability is subject to the approval and/or registration regulations of the respective country. Please contact Waldemar Link GmbH & Co. KG if you have questions about the availability of LINK products in your country.

Waldemar Link GmbH & Co. KG and/or other corporate affiliated entities own, use or have applied for the following trademarks in many jurisdictions: LINK, BiMobile, SP11, Modell Lubinus, E-Dur, EndoDur, T.O.P. II, BetaCup, CombiCup PF, CombiCup SC, CombiCup R, MobileLink, C.F.P., LCU, SP-CL, LCP, MIT-H, Endo-Model, Endo-Model SL, MP, MEGASYSTEM-C, GEMINI SL, SPAR-K, LCK, Link OptiStem, HX, TiCaP, X-LINKed, PorAg, LINK PorEx, BiPorEx, PorEx-Z, TrabecuLink, Tilastan, customLINK, RescueSleeve, Stactip, VACUCAST.

Other trademarks and trade names may be used in this document to refer to either the entities claiming the marks and/or names or their products and are the property of their respective owners.

 Waldemar Link GmbH & Co. KG

Barkhausenweg 10 · 22339 Hamburg · Germany

Phone +49 40 53995-0 · info@link-ortho.com

www.link-ortho.com

